

ULTRA SA



Pompe centrifughe multistadio orizzontali **autoadescanti**. Adatte alla movimentazione di liquidi non carichi; sistemi di pressurizzazione; irrigazione; acque potabili o con glicole in soluzione; trattamento acque; industria alimentare; riscaldamento e condizionamento; sistemi di lavaggio.

Stainless steel multistage horizontal **self-priming** pumps. Pumping of clean non-loaded fluids; pressurizing system; irrigation; drinking and glycol water; water treatment; heating and air conditioning; washing system.

Bombas centrífugas multietapas horizontales **autocebantes**. Bombeo de líquidos químicamente y mecánicamente no agresivos; sistemas de presurización; riegos; agua potable o con glicol; tratamientos del agua; industria alimenticia; calefacción y refrigeración; sistemas de lavado.

Pompes centrifuges multicellulaires horizontales **auto-amorçantes**. Pompage d'eaux propres non chargées; groupes de surpression; irrigation; eau potable ou solution de glycol; traitement des eaux; industrie alimentaire; chauffage et climatisation; stations de lavage auto.

CARATTERISTICHE COSTRUTTIVE / CONSTRUCTION FEATURES CARACTERÍSTICAS CONSTRUCTIVAS / CARACTÉRISTIQUES D'EXÉCUTION

Corpo pompa Pump body	acciaio cromo-nichel AISI 304 stainless steel AISI 304
Cuerpo bomba Corps de pompe	acero cromo-níquel AISI 304 acier chrome-nickel AISI 304
Supporto motore Motor bracket	alluminio aluminium
Soporte motor Support moteur	aluminio aluminium
Giranti, diffusori Impellers, diffusers	acciaio cromo-nichel AISI 304 stainless steel AISI 304
Rodetes, difusores Turbines, diffuseurs	acero cromo-níquel AISI 304 acier chrome-nickel AISI 304
Tenuta meccanica Mechanical seal	ceramica-grafite ceramic-graphite
Sello mecánico Garniture mécanique	cerámica-grafito céramique-graphite
Albero motore Motor shaft	acciaio cromo-nichel AISI 303 stainless steel AISI 303
Eje motor Arbre moteur	acero cromo-níquel AISI 303 acier chrome-nickel AISI 303
Temperatura del liquido Liquid temperature	-15 ÷ +110 °C
Temperatura del liquido Température du liquide	-15 ÷ +110 °C
Pressione di esercizio Operating pressure	max 7 bar
Presión de trabajo Pression de fonctionnement	max 7 bar
MOTORE / MOTOR / MOTOR / MOTEUR	
Motore 2 poli a induzione 2 pole induction motor	3~ 230/400V-50Hz 1~ 230V-50Hz
Motor de 2 polos a inducción Moteur à induction à 2 pôles	(con termoprotettore fino a 1,85kW with thermal protection up to 1,85 kW con protección térmica hasta 1,85 kW avec protection thermique jusqu'à 1,85 kW)
Classe di isolamento Insulation class	F
Clase de aislamiento Classe d'isolation	F
Grado di protezione Protection degree	IP44
Grado de protección Protection	IP44

U 3 S A - 100/5 T

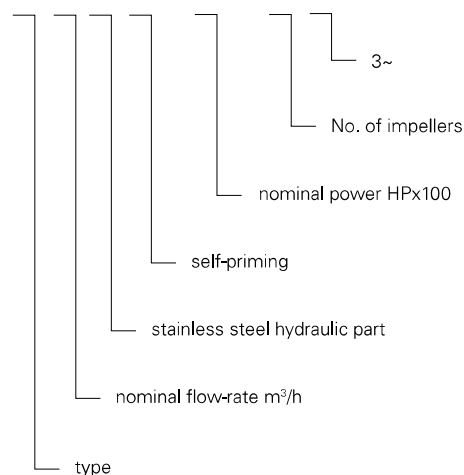

3 SA

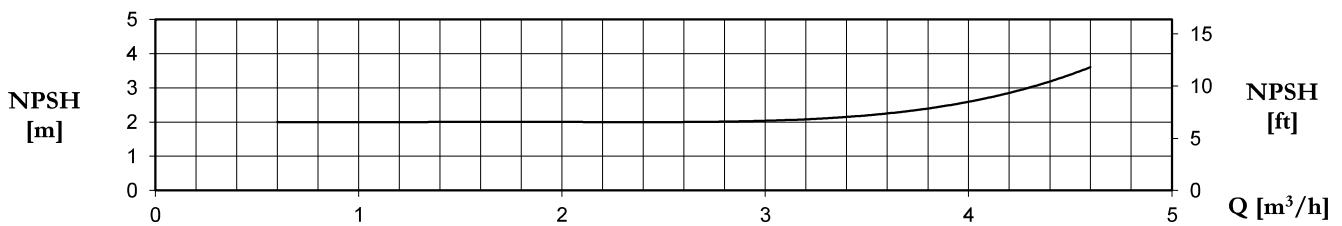
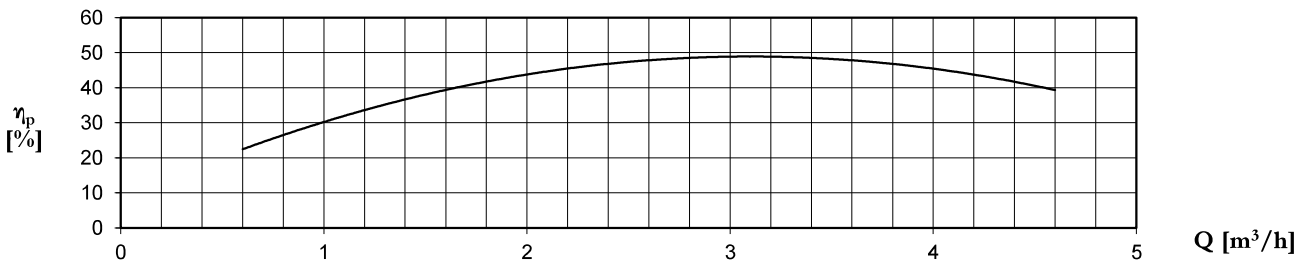
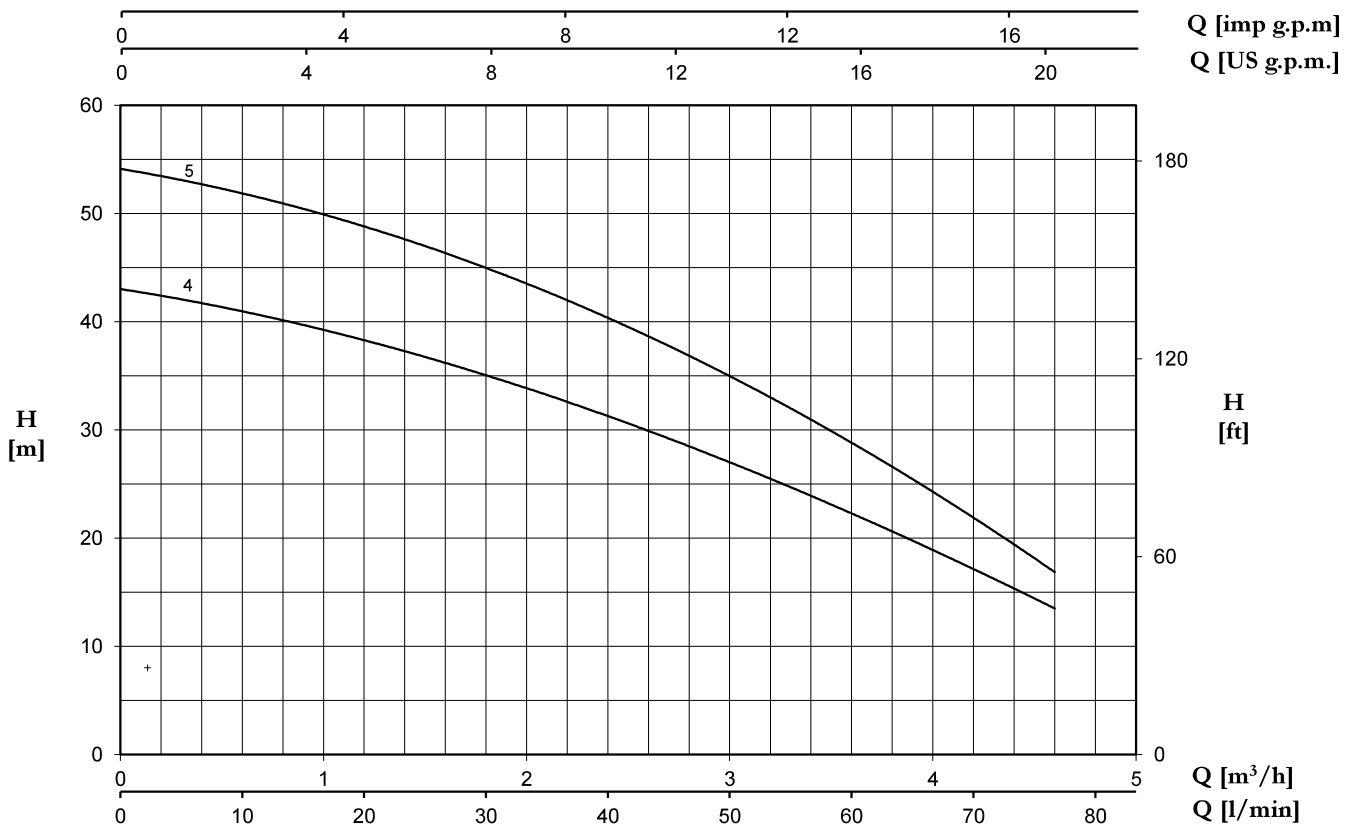

TYPE		P2		P1 (kW)		AMPERE		Q (m³/h - l/min)						
1~	3~					1~	3~	0	0,6	1,2	1,8	2,4	3,6	4,6
		(HP)	(kW)	1~	3~	1x230 V 50 Hz	3x400 V 50 Hz	H (m)						
U 3SA-90/4	U 3SA-90/4T	0,9	0,66	0,83	0,8	3,6	1,7	43,0	41,0	38,3	35,0	31,3	22,3	13,5
U 3SA-100/5	U 3SA-100/5T	1	0,75	0,99	0,92	4,4	1,7	54,0	52,1	48,8	44,9	40,2	29,0	16,8

ULTRA SA

5 SA

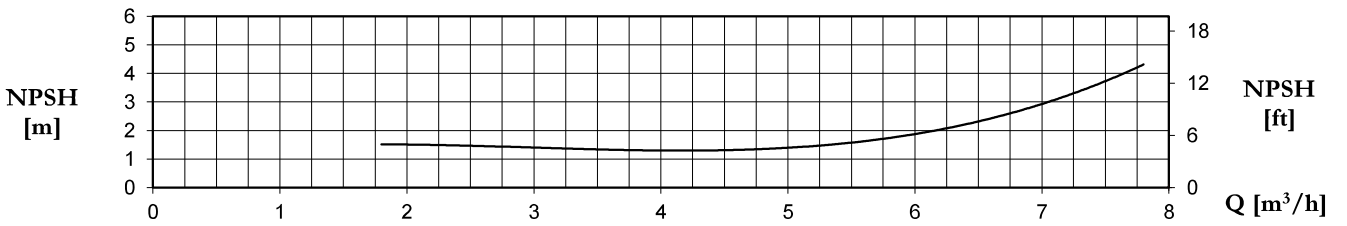
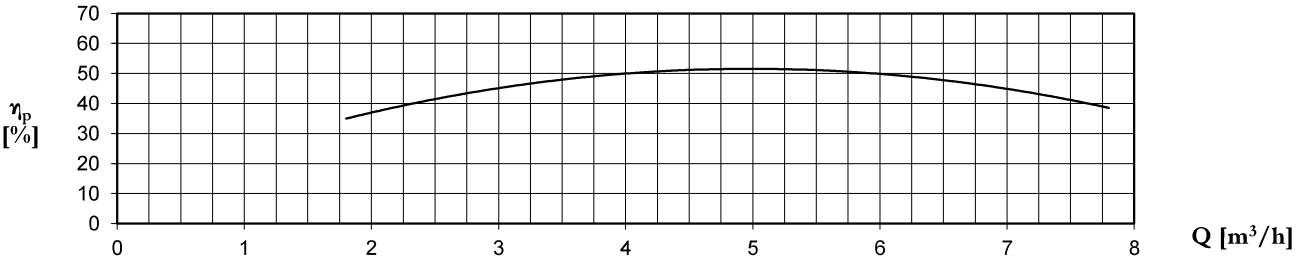
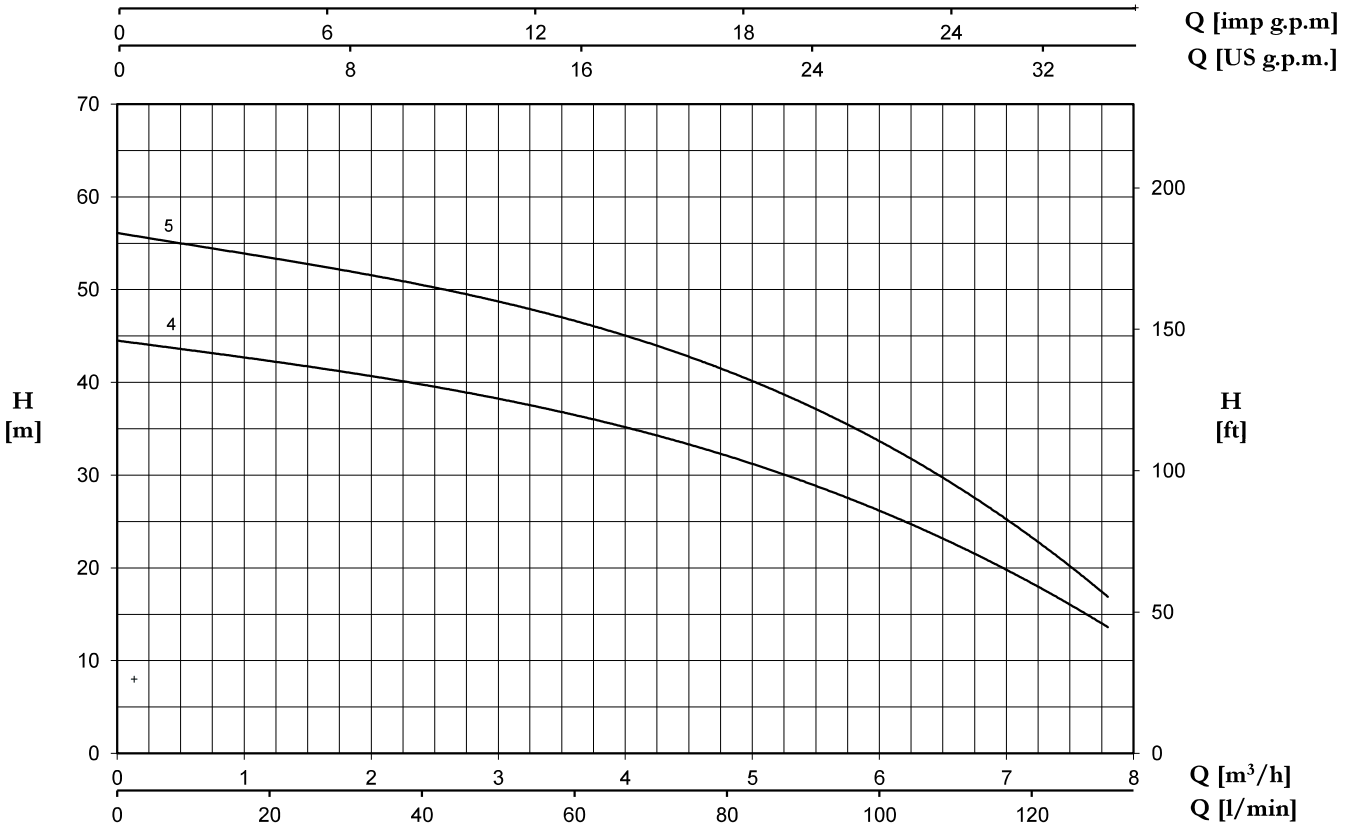

TYPE		P2		P1 (kW)		AMPERE		Q (m³/h - l/min)							
1~	3~					1~	3~	0	1,8	2,4	3,6	4,8	6	7,2	7,8
		(HP)	(kW)	1~	3~	1x230 V 50 Hz	3x400 V 50 Hz	H (m)							
U 5SA-120/4	U 5SA-120/4T	1,2	0,9	1,09	1,08	4,9	2,4	44,5	41,0	40,0	36,4	32,0	26,2	18,5	13,5
U 5SA-150/5	U 5SA-150/5T	1,5	1,1	1,39	1,31	6,5	2,7	56,0	52,4	50,5	46,4	41,0	33,8	23,8	16,5

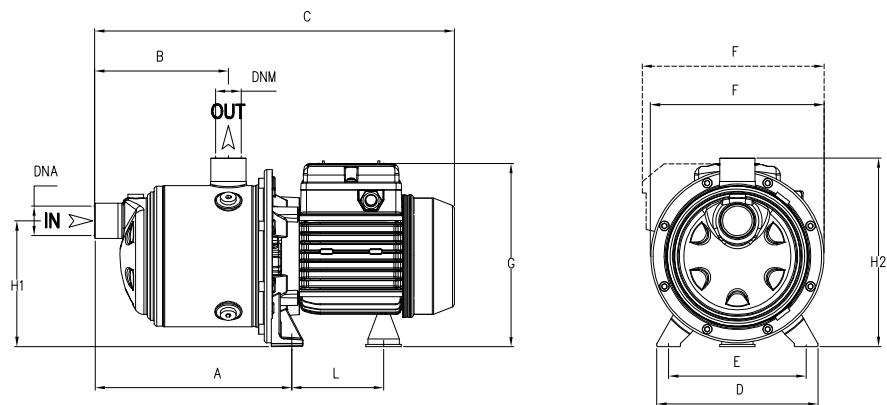

TYPE	DIMENSIONS (mm)										Kg	DNA	DNM
	A	B	C	D	E	F	G	L	H1	H2			
U 3SA-90/4	190,8	175,0	405,0	164,0	140,0	178,0	190,0	93,7	128,0	192,0	9,6	1" G	1" G
U 3SA-100/5	214,8	199,0	452,0	164,0	140,0	178,0	203,0	104,7	128,0	192,0	12,2		
U 5SA-120/4	190,8	175,0	428,0	164,0	140,0	178,0	203,0	104,7	128,0	192,0	12,3		
U 5SA-150/5	214,8	199,0	484,0	164,0	140,0	201,0	211,0	128,2	134,0	198,0	15,1		

	TYPE	TRUCK		CONTAINER	
		PALLET (cm)	N° pumps	PALLET (cm)	N° pumps
		U 3SA-90/4	85x110x160	70	85x110x185
	U 3SA-100/5	80x120x150	42	80x120x175	49
	U 5SA-120/4	80x120x150	42	80x120x175	49
	U 5SA-150/5	80x120x150	42	80x120x175	49