

# ULTRA



ULTRA 3



ULTRA 5



ULTRA 7



ULTRA 9



ULTRA 18



Pompe centrifughe multistadio orizzontali. Adatte alla movimentazione di liquidi non carichi; sistemi di pressurizzazione; irrigazione; acque potabili o con glicole in soluzione; trattamento acque; industria alimentare; riscaldamento e condizionamento; sistemi di lavaggio.

Stainless steel multistage horizontal pumps. Pumping of clean non-loaded fluids; pressurizing system; irrigation; drinking and glycol water; water treatment; heating and air conditioning; washing system.

Bombas centrífugas multietapas horizontales. Bombeo de líquidos químicamente y mecánicamente no agresivos; sistemas de presurización; riegos; agua potable o con glycol; tratamientos del agua; industria alimenticia; calefacción y refrigeración; sistemas de lavado.

Pompes centrifuges multicellulaires horizontales. Pompage d'eaux propres non chargées; groupes de surpression; irrigation; eau potable ou solution de glycol; traitement des eaux; industrie alimentaire; chauffage et climatisation; stations de lavage auto.

## CARATTERISTICHE COSTRUTTIVE / CONSTRUCTION FEATURES CARACTERÍSTICAS CONSTRUCTIVAS / CARACTÉRISTIQUES D'EXÉCUTION

<b>Corpo pompa</b> <b>Pump body</b>	acciaio cromo-nickel AISI 304 stainless steel AISI 304
<b>Cuerpo bomba</b> <b>Corps de pompe</b>	acero cromo-níquel AISI 304 acier chrome-nickel AISI 304
<b>Supporto motore</b> <b>Motor bracket</b>	alluminio aluminium
<b>Soporte motor</b> <b>Support moteur</b>	aluminio aluminium
<b>Giranti, diffusori</b> <b>Impellers, diffusers</b> <b>Rodetes, difusores</b> <b>Turbines, diffuseurs</b>	Noryl®
<b>Tenuta meccanica</b> <b>Mechanical seal</b>	ceramica-grafite ≤ 6 giranti grafite-carburo di silicio ≥ 7 giranti ceramic-graphite ≤ 6 impellers graphite-silicon carbide ≥ 7 impellers
<b>Sello mecánico</b> <b>Garniture mécanique</b>	cerámica-grafito ≤ 6 rodetes grafito-carburo de silicio ≥ 7 rodetes céramique-graphite ≤ 6 turbines graphite-carbure de silicium ≥ 7 turbines
<b>Albero motore</b> <b>Motor shaft</b> <b>Eje motor</b> <b>Arbre moteur</b>	acciaio cromo-nickel AISI 303 stainless steel AISI 303 acero cromo-níquel AISI 303 acier chrome-nickel AISI 303
<b>Temperatura del liquido</b> <b>Liquid temperature</b> <b>Temperatura del liquido</b> <b>Température du liquide</b>	-5 ÷ +35 °C
<b>Pressione di esercizio</b> <b>Operating pressure</b> <b>Presión de trabajo</b> <b>Pression de fonctionnement</b>	max 8,5 bar
<b>MOTORE / MOTOR / MOTOR / MOTEUR</b>	
<b>Motore 2 poli a induzione</b> <b>2 pole induction motor</b> <b>Motor de 2 polos a inducción</b> <b>Moteur à induction à 2 pôles</b>	3~ 230/400V-50Hz 1~ 230V-50Hz (con termoprotettore fino a 1,85kW with thermal protection up to 1,85 kW con protección térmica hasta 1,85 kW avec protection thermique jusqu'à 1,85 kW)
<b>Classe di isolamento</b> <b>Insulation class</b> <b>Clase de aislamiento</b> <b>Classe d'isolation</b>	F
<b>Grado di protezione</b> <b>Protection degree</b> <b>Grado de protección</b> <b>Protection</b>	IP44

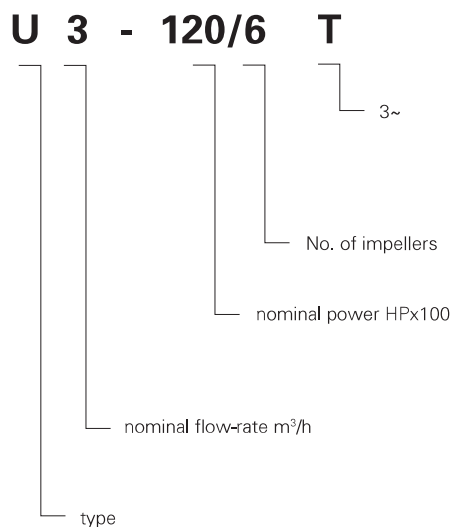

3

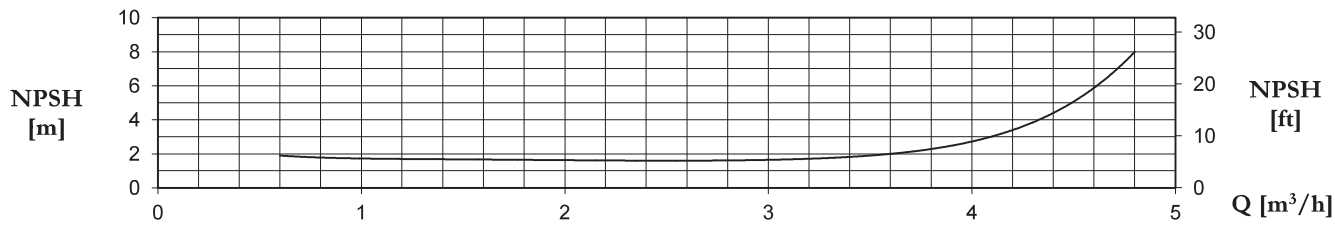
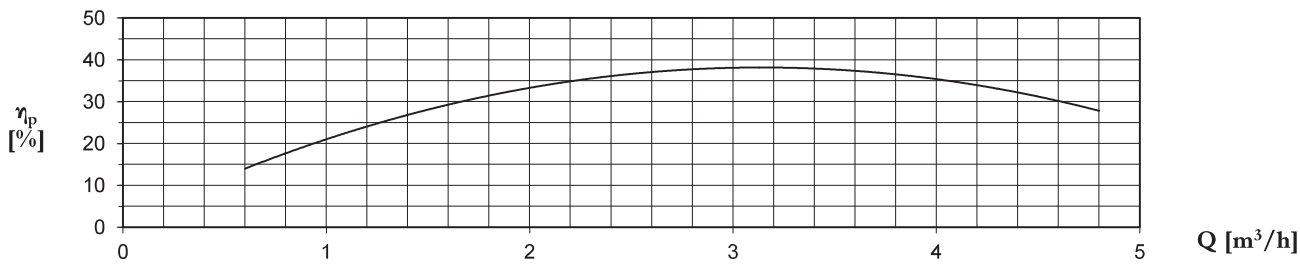
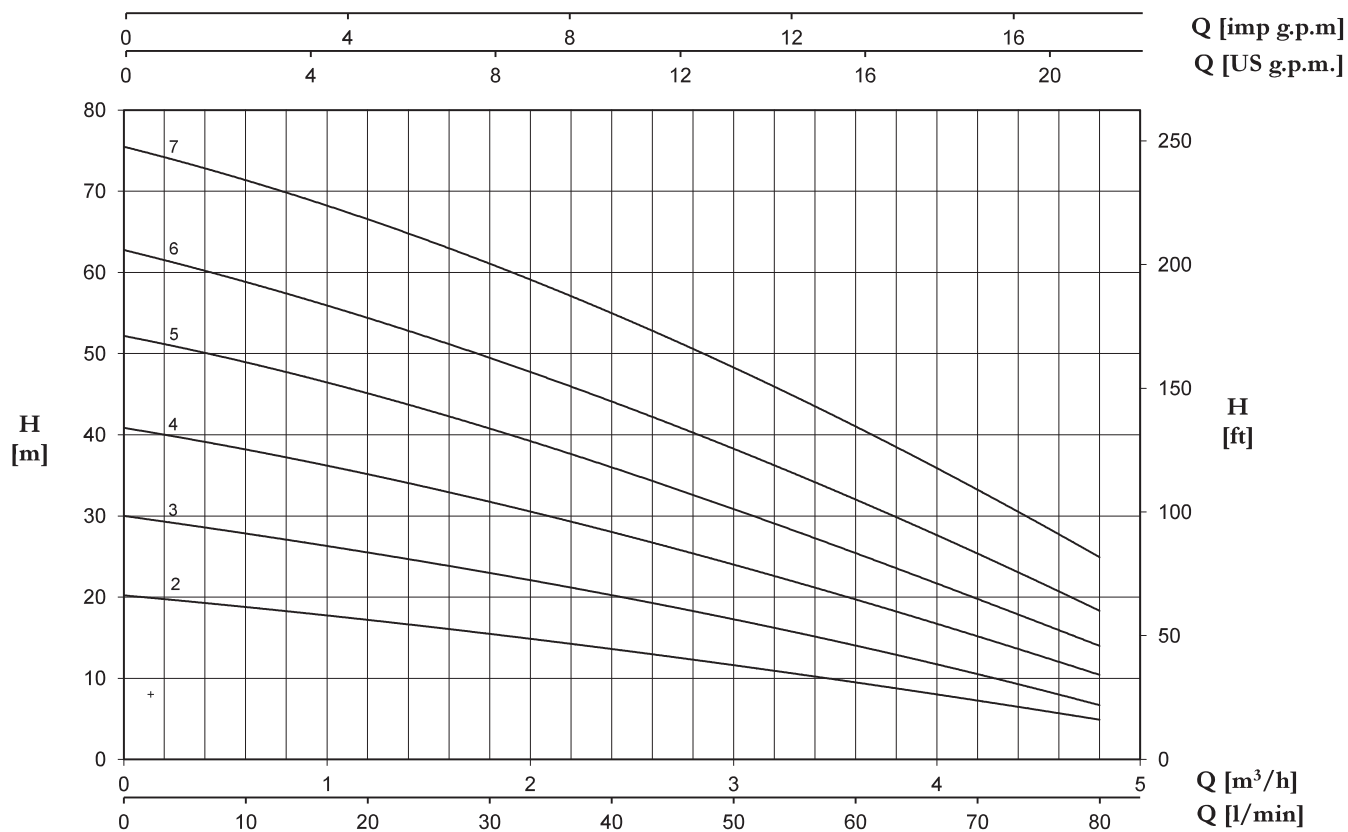

TYPE		P2		P1 (kW)		AMPERE		Q (m³/h - l/min)						
1~	3~					1~	3~	0	0,6	1,2	1,8	2,4	3,6	4,8
		(HP)	(kW)	1~	3~	1x230 V 50 Hz	3x400 V 50 Hz	H (m)						
U 3-50/2	U 3-50/2 T	0,5	0,37	0,45	0,46	2	0,9	20,2	18,8	17,3	15,3	13,7	9,5	4,9
U 3-70/3	U 3-70/3 T	0,7	0,51	0,65	0,63	2,9	1,2	30	27,9	25,4	23	20,3	14	6,7
U 3-90/4	U 3-90/4 T	0,9	0,66	0,9	0,88	4	1,8	40,8	38,3	35,1	31,8	27,9	19,8	10,4
U 3-100/5	U 3-100/5 T	1	0,75	1,06	1,01	4,8	1,9	52,2	48,9	45,1	40,8	36	25,4	14
U 3-120/6	U 3-120/6 T	1,2	0,9	1,23	1,23	5,6	2,6	62,8	58,7	54,5	49,6	43,9	32,1	18,3
U 3-150/7	U 3-150/7 T	1,5	1,1	1,54	1,45	7,1	2,9	75,5	71,3	66,6	61,2	54,8	41,1	24,9

5

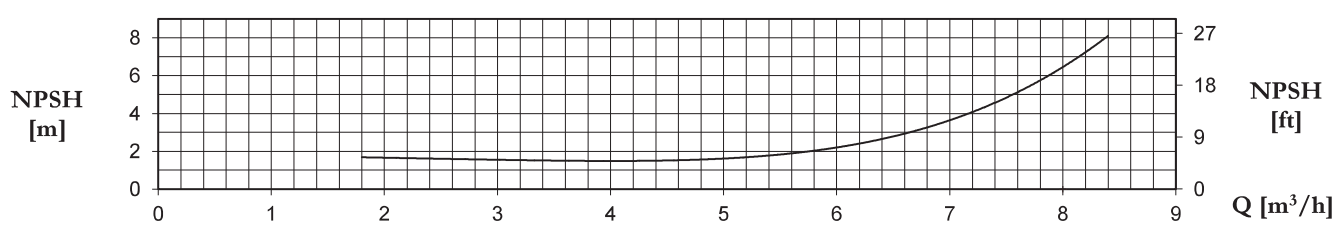
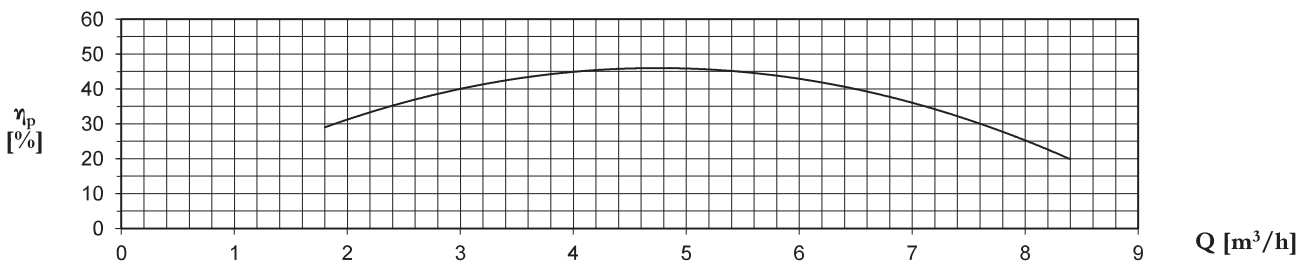
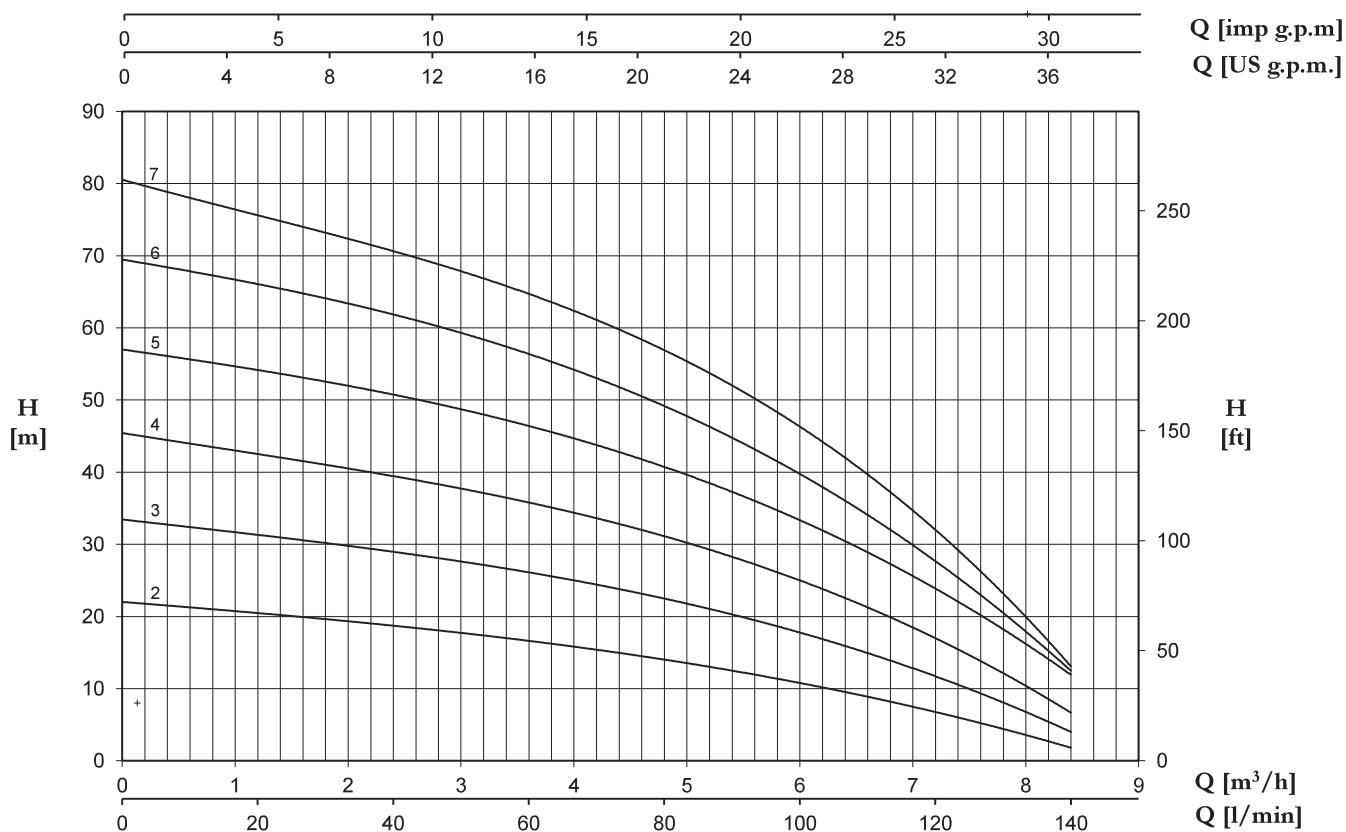

TYPE		P2		P1 (kW)		AMPERE		Q (m³/h - l/min)							
1~	3~					1~	3~	0	1,8	2,4	3,6	4,8	6	7,2	8,4
		(HP)	(kW)	1~	3~	1x230 V 50 Hz	3x400 V 50 Hz	H (m)							
U 5-70/2	U 5-70/2 T	0,7	0,51	0,61	0,58	2,7	1,1	22	19,7	18,7	16,6	14	10,8	6,8	1,8
U 5-80/3	U 5-80/3 T	0,8	0,6	0,86	0,79	3,9	1,5	33,4	30,3	29	26	22,5	17,6	12	3,9
U 5-120/4	U 5-120/4 T	1,2	0,9	1,13	1,13	5,2	2,5	45,3	41,3	39,6	35,6	30,8	24,9	17,6	6,4
U 5-150/5	U 5-150/5 T	1,5	1,1	1,47	1,39	6,8	2,8	56,8	53	51	46,1	40,1	33,3	24,8	11,5
U 5-180/6	U 5-180/6 T	1,8	1,3	1,7	1,62	7,7	3	69,3	64,4	62	55,6	48,2	39,6	28,8	12
U 5-200/7	U 5-200/7 T	2	1,5	2	1,86	9	3,4	80,3	73,6	71	64,5	56,1	46	33,4	12,5

7

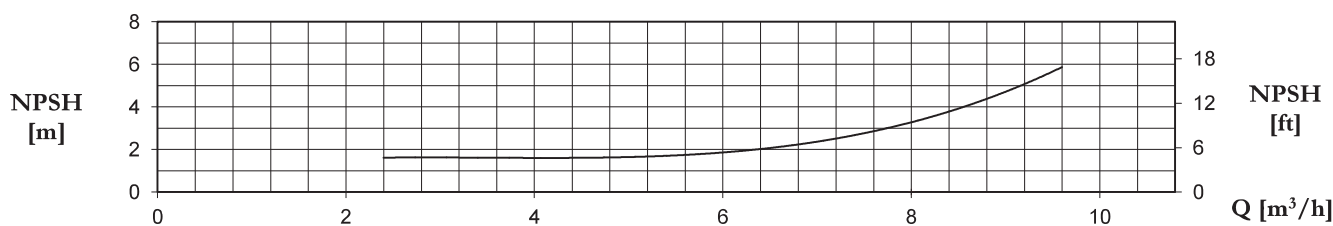
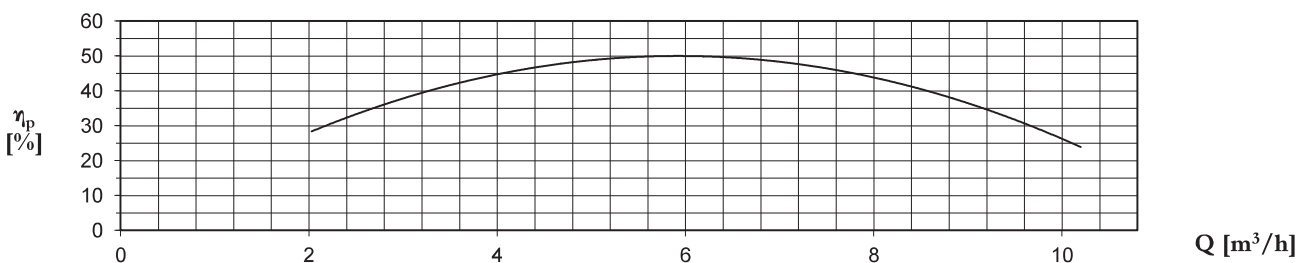
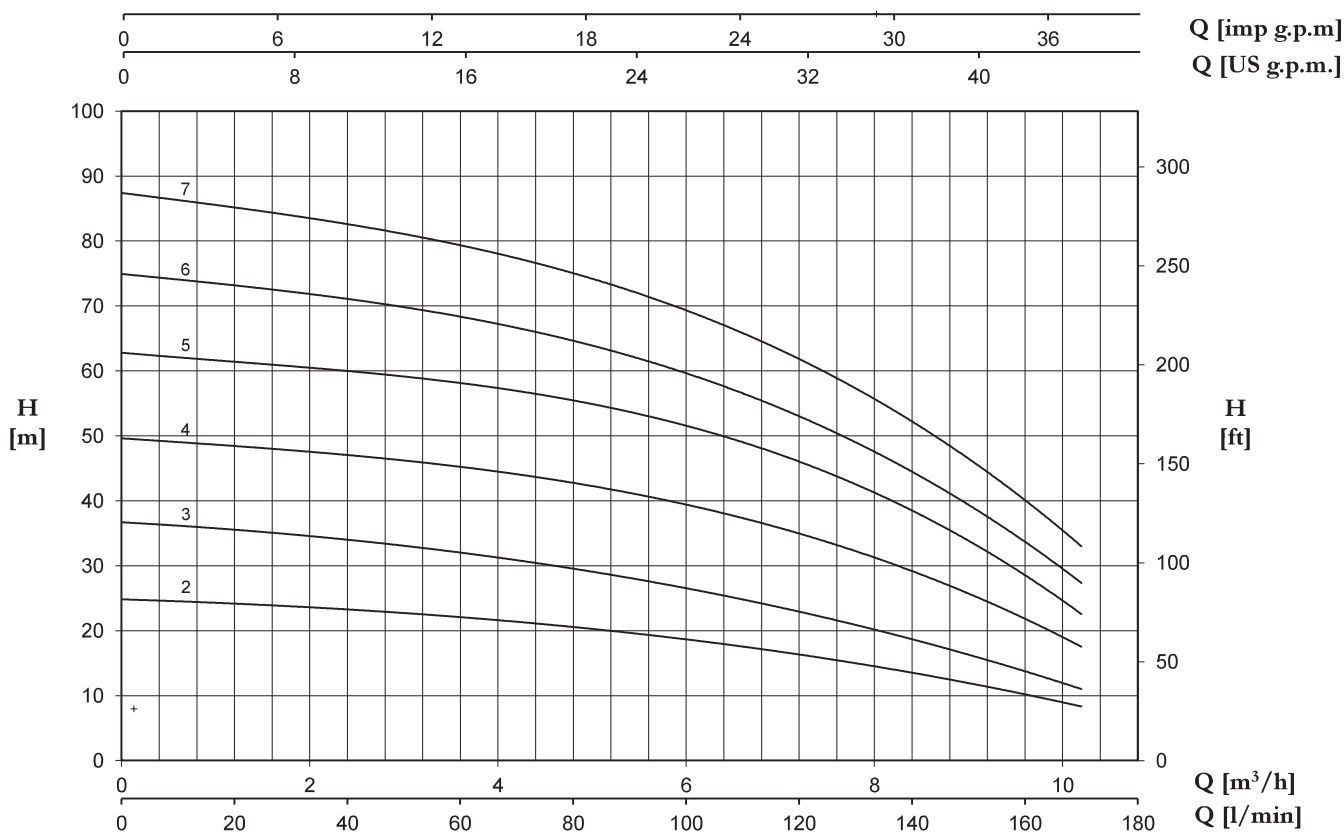

TYPE		P2		P1 (kW)		AMPERE		Q (m³/h - l/min)								
1~	3~					1~	3~	0	2,4	3,6	4,8	6	7,2	8,4	9,6	10,2
		(HP)	(kW)	1~	3~	1x230 V 50 Hz	3x400 V 50 Hz	H (m)								
U 7-100/2	U 7-100/2 T	1	0,75	0,97	0,9	4,4	1,7	24,8	23,4	22	20,5	18,7	16,3	13,6	10,2	8,3
U 7-120/3	U 7-120/3 T	1,2	0,9	1,32	1,3	5,9	2,6	36,7	34	32	29,6	26,5	23	18,6	13,8	11
U 7-180/4	U 7-180/4 T	1,8	1,3	1,83	1,71	8,3	3,2	49,5	47,4	45,3	42,5	39,2	34,8	29,4	22,6	16,9
U 7-250/5	U 7-250/5 T	2,5	1,85	2,39	2,15	10,9	4,2	62,6	60,6	58,2	55,1	51,1	45,8	39	29,8	21,5
U 7-300/6	U 7-300/6 T	3	2,2	2,68	2,63	12,2	5	74,8	71,5	68,3	64,5	59,3	53	44,6	34,5	26,7
-	U 7-350/7 T	3,5	2,57	-	3,04	-	5,5	87,2	83,3	79,3	74,6	68,9	61,9	52,5	41	32,2

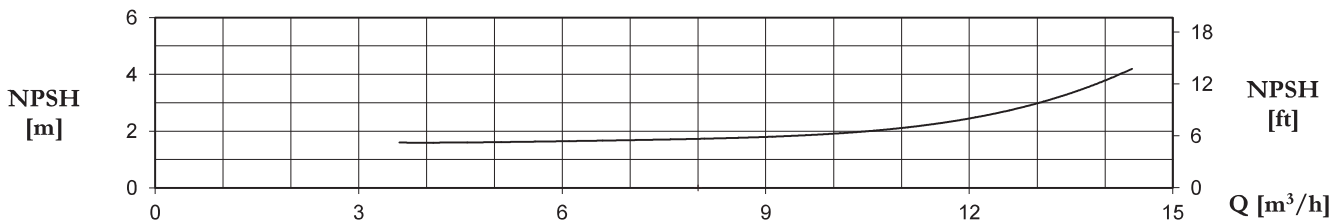
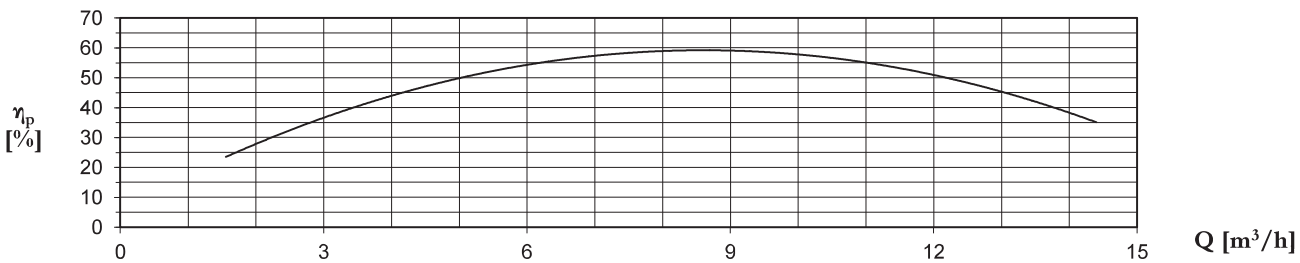
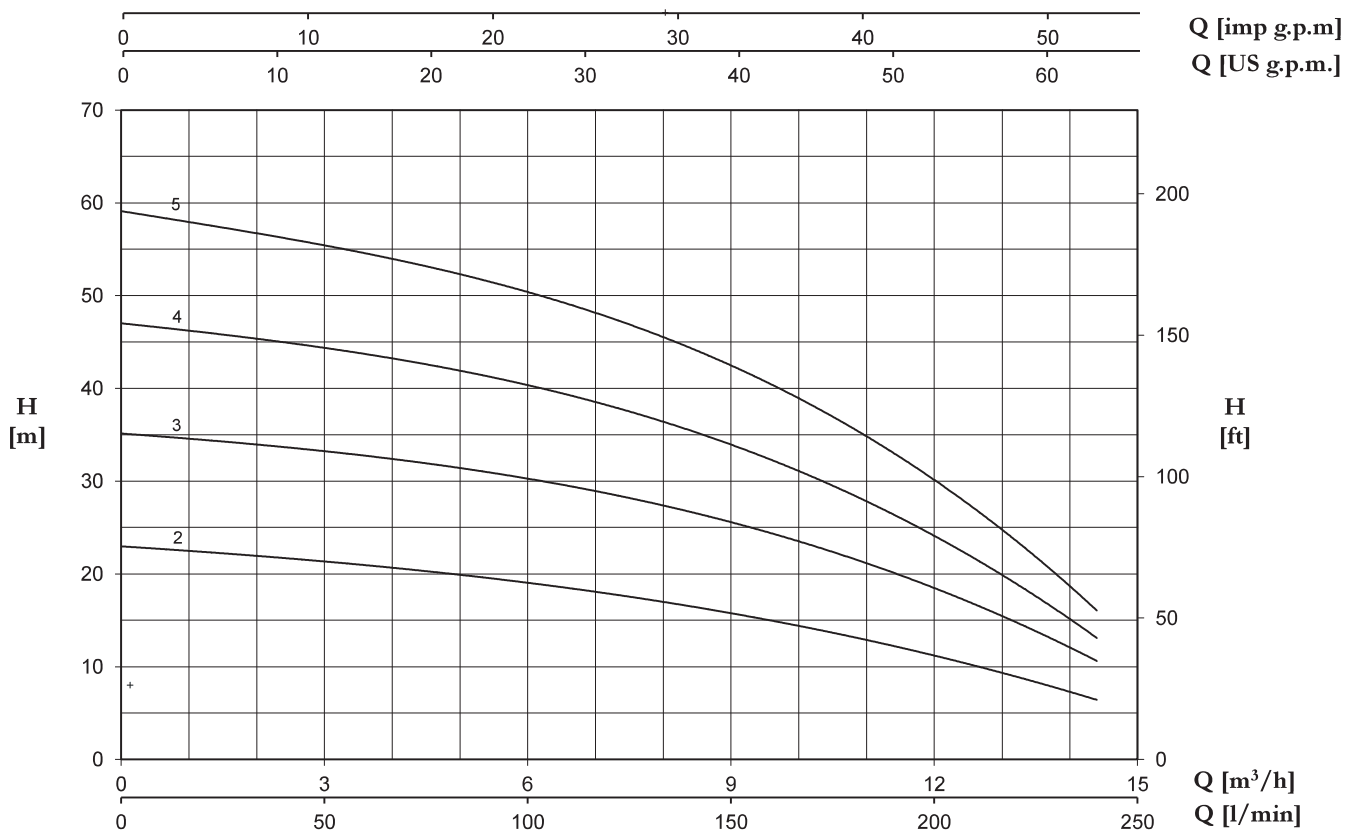

TYPE		P2		P1 (kW)		AMPERE		Q (m³/h - l/min)										
1~	3~	(HP)	(kW)	1~	3~	1~	3~	0	3,6	4,8	6	7,2	8,4	9,6	10,8	12	13,2	14,4
						50 Hz	50 Hz	0	60	80	100	120	140	160	180	200	220	240
								H (m)										
U 9-100/2	U 9-100/2 T	1	0,75	0,98	0,92	4,4	1,7	23	20,9	20	19,1	17,9	16,6	15	13,2	11,1	8,9	6,5
U 9-150/3	U 9-150/3 T	1,5	1,1	1,43	1,38	6,7	2,8	35,2	32,6	31,5	30,3	28,8	26,9	24,5	21,5	18,3	14,7	10,8
U 9-200/4	U 9-200/4 T	2	1,5	1,88	1,77	8,4	3,3	47,1	43,5	42	40,5	38,3	35,7	32,4	28,4	23,8	18,9	13,3
U 9-250/5	U 9-250/5 T	2,5	1,85	2,32	2,18	10,6	4,3	59,2	54,4	52,4	50,4	47,9	44,8	40,5	35,5	29,8	23,5	16,3

# 18

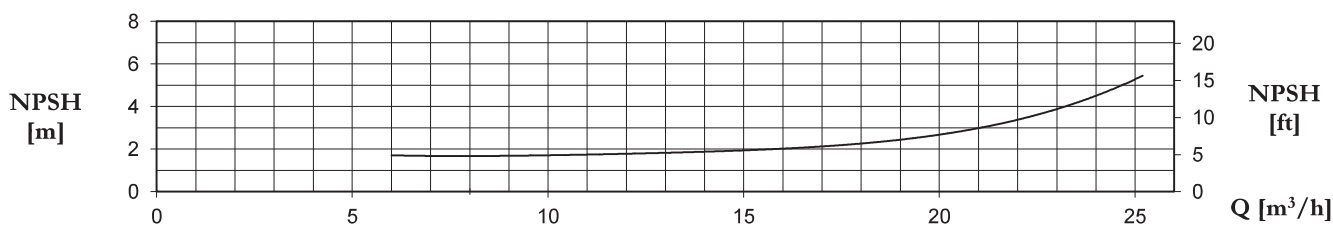
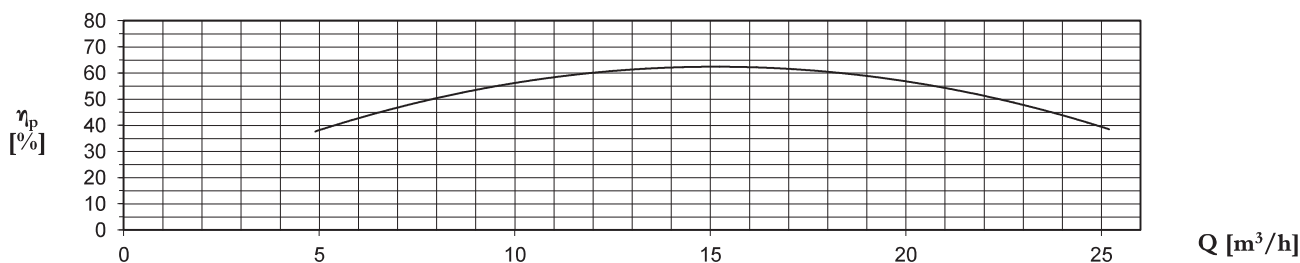
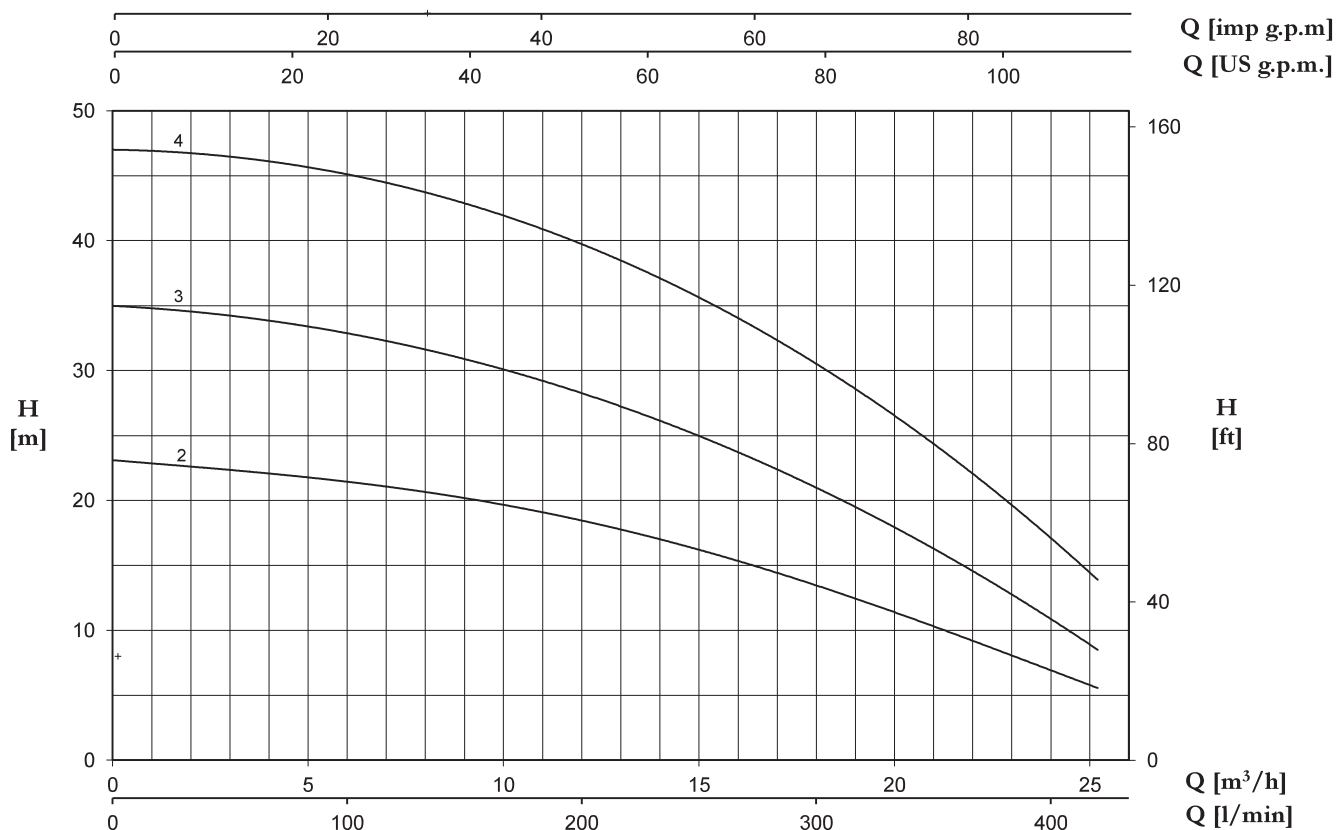

TYPE	P2		P1 (kW)	A	Q (m³/h - l/min)																	
					3~																	
					3x400 V 50 Hz																	
(HP)	(kW)	3~	H (m)																			
U 18-180/2 T	1,8	1,3	1,52	3	23,1	21,4	21	20,5	19,9	19,2	18,4	17,6	16,7	15,7	14,7	13,5	12,1	10,9	9,7	8,3	7	5,5
U 18-250/3 T	2,5	1,85	2,19	4,3	35	32,7	32,2	31,4	30,5	29,5	28,3	26,7	25,5	24,3	22,8	21,2	19,3	17,3	15,1	12,9	10,8	8,7
U 18-400/4 T	4	3	2,99	5,5	47,2	44,6	44,1	43,3	42,4	41,2	40	38,5	36,7	34,9	32,9	30,5	27,9	25,3	22,7	20	17,1	14,3

ULTRA

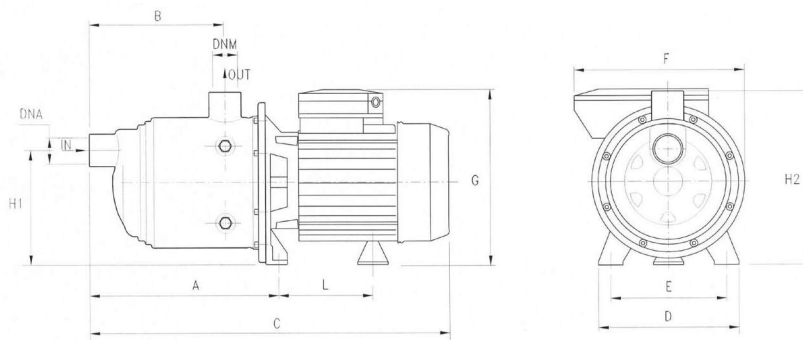

TYPE	DIMENSIONS (mm)										Kg	DNA	DNM
	A	B	C	D	E	F	G	L	H1	H2			
U 3-50/2	166.8	103	333	164	140	178	190	93.7	128	192	6,3	1" G	1" G
U 3-70/3	166.8	103	333	164	140	178	190	93.7	128	192	7,2		
U 3-90/4	190.8	127	357	164	140	178	190	93.7	128	192	8,3		
U 3-100/5	214.8	151	404	164	140	178	203	104.7	128	192	10,6		
U 3-120/6	238.8	175	428	164	140	178	203	104.7	128	192	11		
U 3-150/7	262.8	199	483	164	140	201	211	128.2	134	198	14,1		
U 5-70/2	166.8	103	333	164	140	178	195	93.7	128	192	7,1		
U 5-80/3	166.8	103	357	164	140	178	203	93.7	128	192	9,5		
U 5-120/4	190.8	127	380	164	140	178	203	104.7	128	192	11,1		
U 5-150/5	214.8	151	436	164	140	201	211	128.2	134	198	13,5		
U 5-180/6	238.8	175	459	164	140	201	211	128.2	134	198	14,4		
U 5-200/7	262.8	199	483	164	140	201	211	128.2	134	198	16,2		

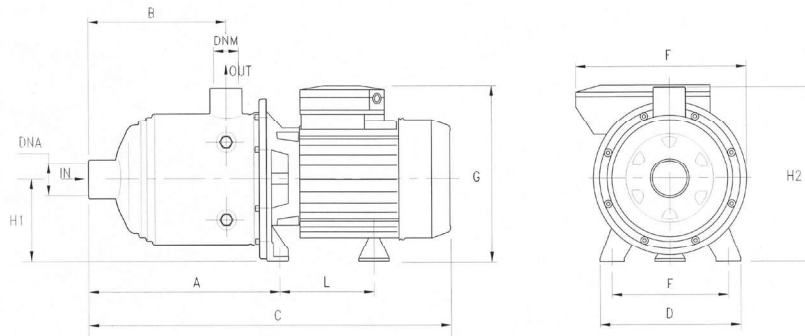

TYPE	DIMENSIONS (mm)										Kg	DNA	DNM
	A	B	C	D	E	F	G	L	H1	H2			
U 7-100/2	166.8	103	356	164	140	178	203	104.7	92	192	10,0	1"1/4 G	1" G
U 7-120/3	166.8	103	356	164	140	178	203	104.7	92	192	10,8		
U 7-180/4	190.8	127	411	164	140	201	211	128.2	98	198	13,8		
U 7-250/5	214.8	151	436	164	140	201	211	128.2	98	198	15,8		
U 7-300/6	238.8	175	M 503 T 459	164	140	201	M 229 T 211	M 148.2 T 128.2	M 103 T 98	M 203 T 198	18,2		
U 7-350/7	262.8	199	527	164	140	201	229	148.2	103	203	18,6		
U 9-100/2	185.8	118	375	164	140	178	203	104.7	98	192	10,1	1"1/2 G	1"1/4 G
U 9-150/3	185.8	118	375	164	140	201	211	128.2	98	198	13,2		
U 9-200/4	215.8	148	436	164	140	201	211	128.2	98	198	15,5		
U 9-250/5	245.8	178	464	164	140	201	211	128.2	98	198	16,1		
U 18-180/2 T	201	141	432	164	140	201	211	128.2	98	198	12,9	2" G	1"1/2 G
U 18-250/3 T	238.5	141	432	164	140	201	211	128.2	98	198	14,5		
U 18-400/4 T	276	178.5	514	164	140	201	229	148,2	103	203	20,8		

TYPE	TRUCK		CONTAINER	
	PALLET (cm)	N° pumps	PALLET (cm)	N° pumps
U 3-50/2-90/4	80X120X150	84	80X120X175	96
U 3-100/5-120/6	85X110X160	70	85X110X185	80
U 3-150/7	80X120X150	42	80X120X175	49
U 5-70/2	80X120X150	84	80X120X175	96
U 5-80/3-120/4	85X110X160	70	85X110X185	80
U 5-150/5	90X110X150	54	90X110X170	63
U 5-180/6-200/7	80X120X150	42	80X120X175	49
U 7-100/2-120/3	85X110X160	70	85X110X185	80
U 7-180/4-250/5	90X110X150	54	90X110X170	63
U 7-300/6 T	80X120X150	42	80X120X175	49
U 7-300/6 M-350/7 T	80X120X145	35	80X120X170	42
U 9-100/2	85X110X160	70	85X110X185	80
U 9-150/3-200/4	90X110X150	54	90X110X170	63
U 9-250/5	80X120X150	42	80X120X175	49
U 18-180/2-250/3	90X110X150	54	90X110X170	63
U 18-400/4	80X120X145	35	80X120X170	42